

RENO DESIGNED FOR 1" HIGH SINK SENSOR SOAP DISPENSER SPECS

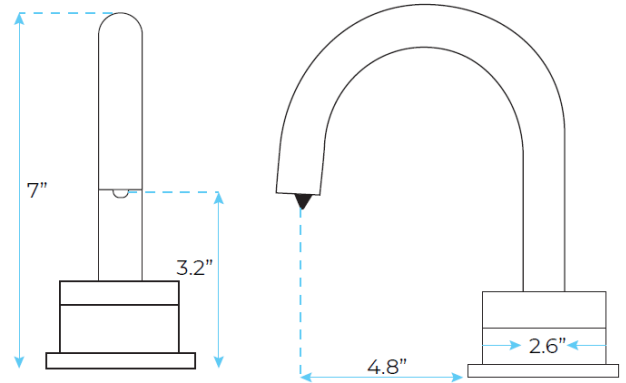

SPECS:

- Product Type: Commercial
- Main Construction Material: Brass
- Mount Type: Deck
- Sensor type: Active Infrared, Self-Adjusting
- Power Rating: 4 (D) Batteries / AC Adapter Optional
- Soap Pump: 6 Volt Noise-Free
- Number of Tap Holes: 1
- Valve/Cartridge Type: Solenoid Valve
- Plumbing System Requirements: Suitable for all plumbing systems
- Sensing Range: Adjustable with remote control
- Activation Time: 0.5 - 1 secs
- Soap Bottle Capacity: 800ML optional 1 gallon containers
- Soap Amount Per Use: 0.5ML to 1.5ML (adjustable)

